

INSTALLATION GUIDE

Zigzag Strip Light

WARNING

Electrical shock risk. Do not modify these products, as any alterations may void the warranty and compromise safety. Installation requires knowledge of electrical sign systems; if you are not qualified, please consult a certified electrician. Always disconnect the power supply before installing the product. Ensure the correct driver (12V or 24V) and adequate maximum wattage are used. Adhere to the specified guidelines for optimal results.

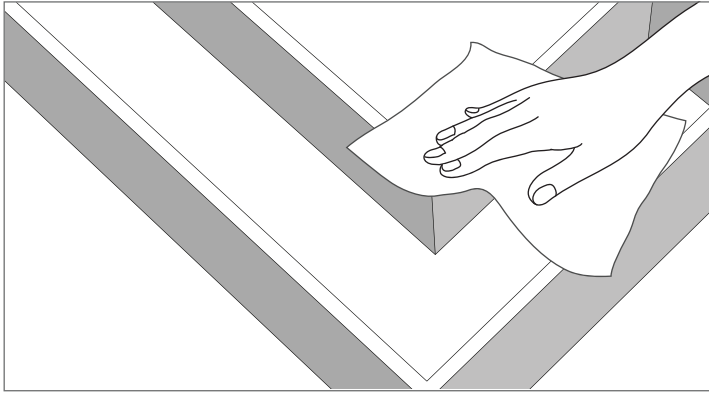

- 1** Clean and dry the inside of your channel letter, where you're going to install the Zigzag strip lights, ensuring it is free from any debris or dirt.

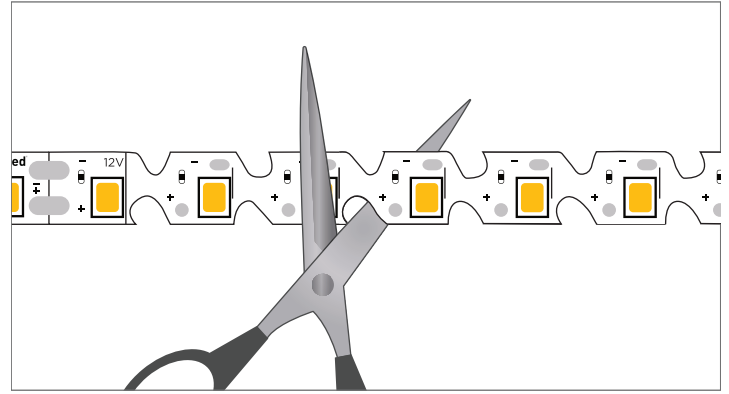

- 2** Cut the Zigzag strip to the required length by following the cutting mark, ensuring that you prevent damage to the light.

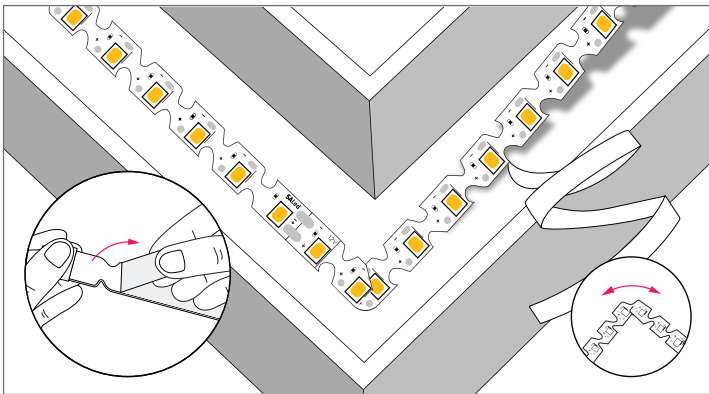

- 3** Remove the adhesive tape and position the strips, bending them to follow the contours of your lettering forms. Avoid removing and reapplying the strip (see Figure 1 on page 2).

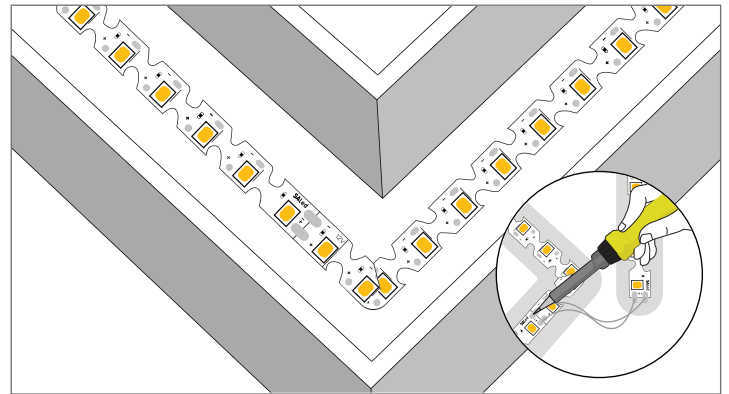

- 4** Strips installed at a distance from each other may require jumper wires to connect them. Be sure to follow the correct polarity (+, -).

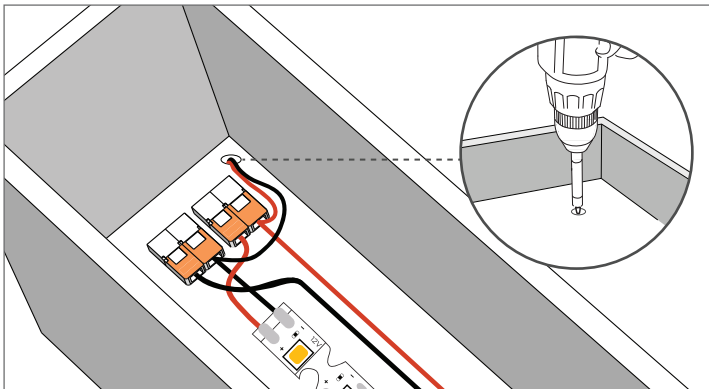

- 5** WAGO connectors enable quick wiring of LEDs in series. Drill holes along the edge of the channel letter connect to the power supply.

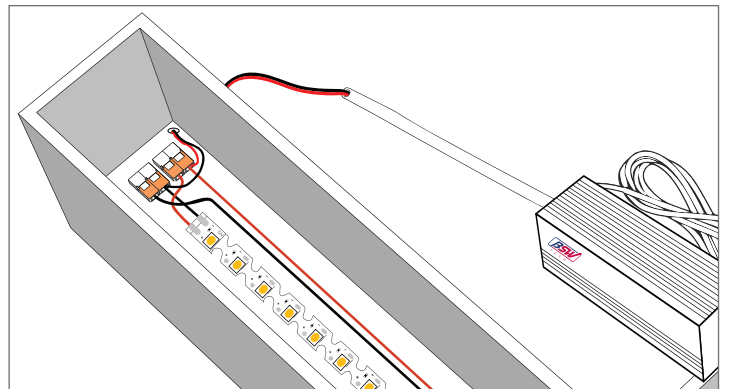

- 6** Wire both ends of Zigzag strips to the power supply. For multiple series, connect them in parallel to avoid voltage drop and ensure brightness (refer to Figure 3 on page 2).

INSTALLATION GUIDE

Zigzag Strip Light

Figure 1. Installation Precautions

Ensure safety and optimal performance by following these essential guidelines during LED strip light installation.

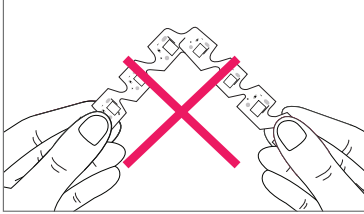

Do not apply excessive force when bending a zigzag strip; it bends naturally.

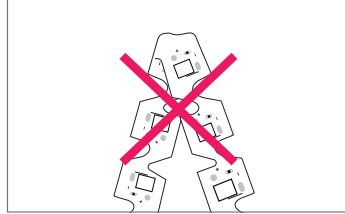

Do not apply extreme bending to the zigzag strip

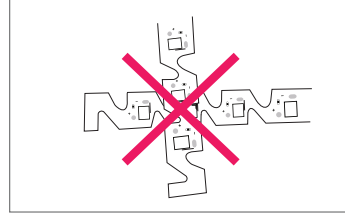

Do not install the LED strip lights overlapping each other.

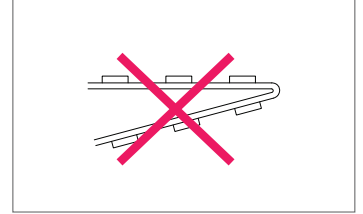

Do not bend the strip along the top & bottom sides. It is only available to bend sideways.

We recommend attaching one side first and then contouring it in the desired direction.

Figure 2. Accessories

We have jump wires for connecting strips with soldering, mounting clips to keep the strip to secure.

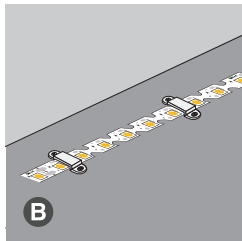
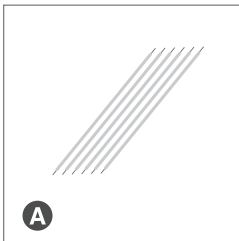

Product	Type	Itemcode	Usage
Jump Wire	A Jump wire	SA 95D1	50mm
		SA 95D2	100mm
		SA 95D3	150mm
*Mount	B Mount & Finish	SA 9911	10mm 12mm

*For mount usage - Primary: Outdoor LED Strips / Optional: Indoor LED Strips

Figure 3. Max In Series

Check Polarity : All connections must be **RED-TO-RED (+)** and **BLACK-TO-BLACK(-)**. Reverse polarity connections may damage the LEDs and will void the product warranty.

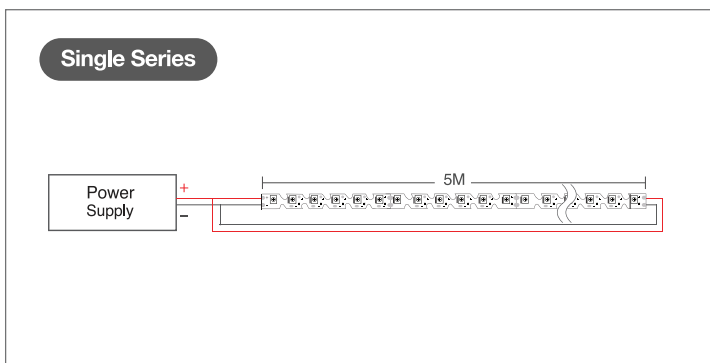

Do not exceed the maximum length of LED strips per series (refer to each item's spec sheet). We recommend wiring both ends of LED strips to the power supply.

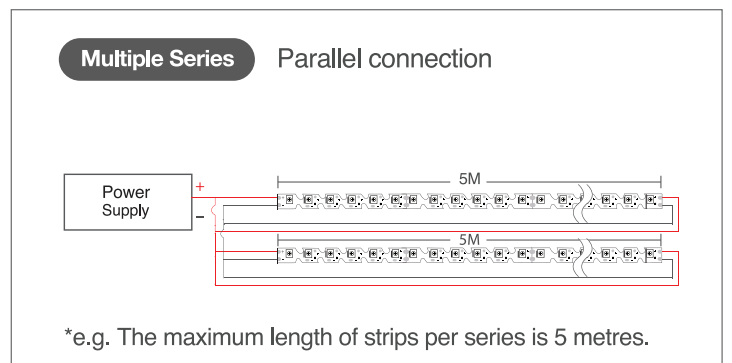

*e.g. The maximum length of strips per series is 5 metres.

If you require **multiple strips**, they must be wired in parallel as a safe electrical operation mode. **Serial connection is not recommended**, as unbalanced voltage drops can lead to hazardous overload, potentially damaging the LED strips and causing uneven brightness.